



A-Series ATV Winch

Operator and Installation Manual

A-Series Operator and Installation Manual























Thank you for choosing Superwinch.

Your Superwinch is a powerful machine and whether you use it for serious recreation or serious work, remember that pulling a load without proper equipment and preparation can be dangerous. The responsibility for safe operation of this winch ultimate rests with you, the operator. Read and understand all safety precautions and operating instructions before installing and operating the winch. Careless winch operation can result in serious injury and/or property damage.

Table of Contents

Page	Topic
3	Safety Symbols
4	Warnings and Cautions
7	A Series Walkthrough
8	Installation
11	Troubleshooting
12	First Time Operating Instructions
16	Using your Winch
18	Help

Safety Symbols

SYMBOL	EXPLANATION	SYMBOL	EXPLANATION
	Read All Product Literature		Always Wear Leather Gloves
	Always Wear Hearing and Eye Protection		Do Not Move People
	Never Use Winch to Hold Load In Place		Always Use Supplied Hand Saver
	Properly Seat Load in Throat of Hook		Never Apply Load to Hook Tip or Latch
	Wind Rope on Bottom of Drum		Never Wind Rope Over Top of Drum
	Finger/Fairlead Crushing Hazard		Pinch Point
	Hand Piercing/Cutting Hazard		Hot Surface Hazard
	Explosion/Bursting Hazard		Fire and Burn Hazard
	Never Route Electrical Cables through Sharp Edges Hazard		Never Route Electrical Cables through or near Moving Parts Hazard
	Never Use Winch to Open, Close or Suspend a Door..		Exposed Wiring Hazard, Insulate Exposed Wiring and Terminals
	Avoid Installing Electrical Cables around Pinch and Wear/Abrasion Points		Never Hook Back on Rope

WARNINGS AND CAUTIONS

Throughout this manual you will find notations with the following headings:



DANGER Indicates an imminently hazardous situation which, if not avoided will result in death or serious injury.



WARNING Indicates a potentially hazardous situation which, if not avoided, could result in death or serious injury.



CAUTION Indicates a potentially hazardous situation which, if not avoided, may result in minor or moderate injury. This notation is also used to alert against unsafe practices.



NOTICE Indicates a potentially hazardous situation which, if not avoided, may result in injury. This notation is also used to alert against unsafe practices or important winch functionality.



MOVING PARTS ENTANGLEMENT HAZARD

Failure to observe these instructions could lead to serious injury or death.

General Safety:

- Know your winch. Get to know the sounds and sights of your winch.
- Take time to fully read this manual to understand your winch and its operations.
- Never exceed winch or winch rope rated capacity.
- Double line using a snatch block to reduce winch load.
- Always wear heavy leather gloves when handling winch rope.
- Never use winch or winch rope for towing. Shock loads can damage, overload and break rope.
- Never use a winch to secure a load.
- Never operate this winch when under the influence of drugs, alcohol or medication.
- Never operate this winch if you are under 16 years of age.
- Never use winch to open, close or suspend a door.

Installation Safety:

- Always choose a mounting location that is sufficiently strong to withstand the maximum pulling capacity of your winch.
- Always use class 8.8 metric (grade 5) or better hardware.
- Never weld mounting bolts.
- Always use factory approved mounting hardware, components, and accessories.
- Never use bolts that are too long.
- Always confirm required bolt length to ensure proper thread engagement.
- Always complete the winch installation and hook attachment before installing the wiring.
- Always keep hands clear of winch rope, hook loop, hook and fairlead opening during installation, operation, and when spooling in or out.
- Always position fairlead with warning readily visible on top.
- Always pre-stretch rope and re-spool under load before use. Tightly wound rope reduces chances of “binding”, which can damage the rope.



MOVING PARTS ENTANGLEMENT HAZARD

Failure to observe these instructions could lead to serious injury or death.

Winching Safety:

- Always remove any element or obstacle that may interfere with safe operation of the winch.
- Always be certain the anchor you select will withstand the load and the strap or chain will not slip.
- Always use supplied hook strap whenever spooling winch rope in or out, during installation and during operation.
- Always require operators and bystanders to be aware of vehicle and or load.
- Always be aware of stability of vehicle and load during winching, keep others away. Alert all bystanders of an unstable condition.
- Always unspool as much winch rope as possible when rigging. Double line or pick distant anchor point.
- Always take time to use appropriate rigging techniques for a winch pull.
- Never touch winch rope or hook while someone else is at the control switch or during winching operation.
- Never engage or disengage clutch if winch is under load, winch rope is in tension or drum is moving.
- Never touch winch rope or hook while under tension or under load.
- Always stand clear of winch rope and load and keep others away while winching.
- Never use vehicle to pull load on winch rope. Combined load or shock load can damage, overload and break rope.
- Never wrap winch rope back onto itself. Use a choker chain or tree trunk protector on the anchor.



MOVING PARTS ENTANGLEMENT HAZARD

Failure to observe these instructions could lead to serious injury or death.

- Always ensure hook with latch is closed and not supporting load.
- Never apply load to hook tip or latch. Apply load only to the center of hook.
- Never use a hook whose throat opening has increased, or whose tip is bent or twisted.

- Always inspect winch rope, hook, and slings before operating winch. Frayed, kinked or damaged winch rope must be replaced immediately. Damaged components must be replaced before operation. Protect parts from damage.

- Always ensure the operator and bystanders are aware of the stability of the vehicle and/or load.
- Always keep wired remote control lead and power cord clear of the drum, rope, and rigging. Inspect for cracks, pinches, frayed wires or loose connections. Damaged components must be replaced before operation.
- Always pass remote lead thru window



MOVING PARTS ENTANGLEMENT HAZARD

Failure to observe these instructions could lead to minor or moderate injury.

- Never leave remote control where it can be activated during free spooling, rigging, or when the winch is not being used.
- Never leave the winch remote control plugged in when installing, freespooling, rigging, servicing or when the winch is not being used.



CHEMICAL AND FIRE HAZARD

Failure to observe these instructions could lead to serious injury or death.

- Always remove jewelry and wear eye protection.
- Never route electrical cables across sharp edges.
- Never route electrical cables near parts that get hot.
- Never route electrical cables through or near moving parts.
- Always place the supplied terminal boots on wires and terminals as directed by the installation instructions.
- Never lean over battery while making connections.
- Never route electrical cables over battery terminals.
- Never short battery terminals with metal objects.
- Always verify area is clear of fuel lines, fuel tank, brake lines, electrical wires, etc., when drilling.
- Always consult operator's manual for proper wiring details.
- Always insulate and protect all exposed wiring and electrical terminals.

NOTICE

AVOID WINCH AND EQUIPMENT DAMAGE

- Always avoid side pulls which can pile up winch rope at one end of the drum. This can damage winch rope or winch.
- Always ensure the clutch is fully engaged or disengaged.
- Always use care to not damage the vehicle frame
- when anchoring to a vehicle during a winching operation.
- Never submerge winch in water.
- Always store the remote control in a protected, clean, dry area

WARNING

FALLING OR CRUSHING HAZARD

Failure to observe these instructions could lead to serious injury or death.

- Always stand clear, keep hands clear, keep others away.
- Never operate winch with less than 5 wraps of rope

around the drum. Rope could come loose from the drum, as the rope attachment to the drum is not designed to hold a load.

- Never use winch as a hoist or to suspend a load.
- Always be certain anchor will withstand load, use appropriate rigging and take time to rig correctly.
- Never use winch to lift or move persons.
- Never use excessive effort to free spool winch rope.
- Always use proper posture/lifting technique or get

WARNING

CUT AND BURN HAZARD

Failure to observe these instructions could lead to serious injury or death.

To avoid injury to hands and fingers:

- Always wear heavy leather gloves when handling winch rope.
- Always be aware of possible hot surfaces at winch

CAUTION

CUT AND BURN HAZARD

Failure to observe these instructions could lead to minor or moderate injury.

- Never let winch rope slip through your hands.

Safe Working Conditions

This manual provides instructions on how to install your Superwinch, winch system and initial operating instructions. Please read the Basic Guide to Winching Techniques for complete operational instructions for your Superwinch winch system.

Safety

When installing your Superwinch winch system, read and follow all mounting and safety instructions. Always use caution when working with electricity and remember to verify that no exposed electrical connections exist before energizing your winch circuit. For specifications and performance data, refer to the specification sheet supplied with your winch.

A-Series Walkthrough

Before you begin, you should familiarize yourself with your Superwinch EXP winch and each of its components:

A-Series Contents

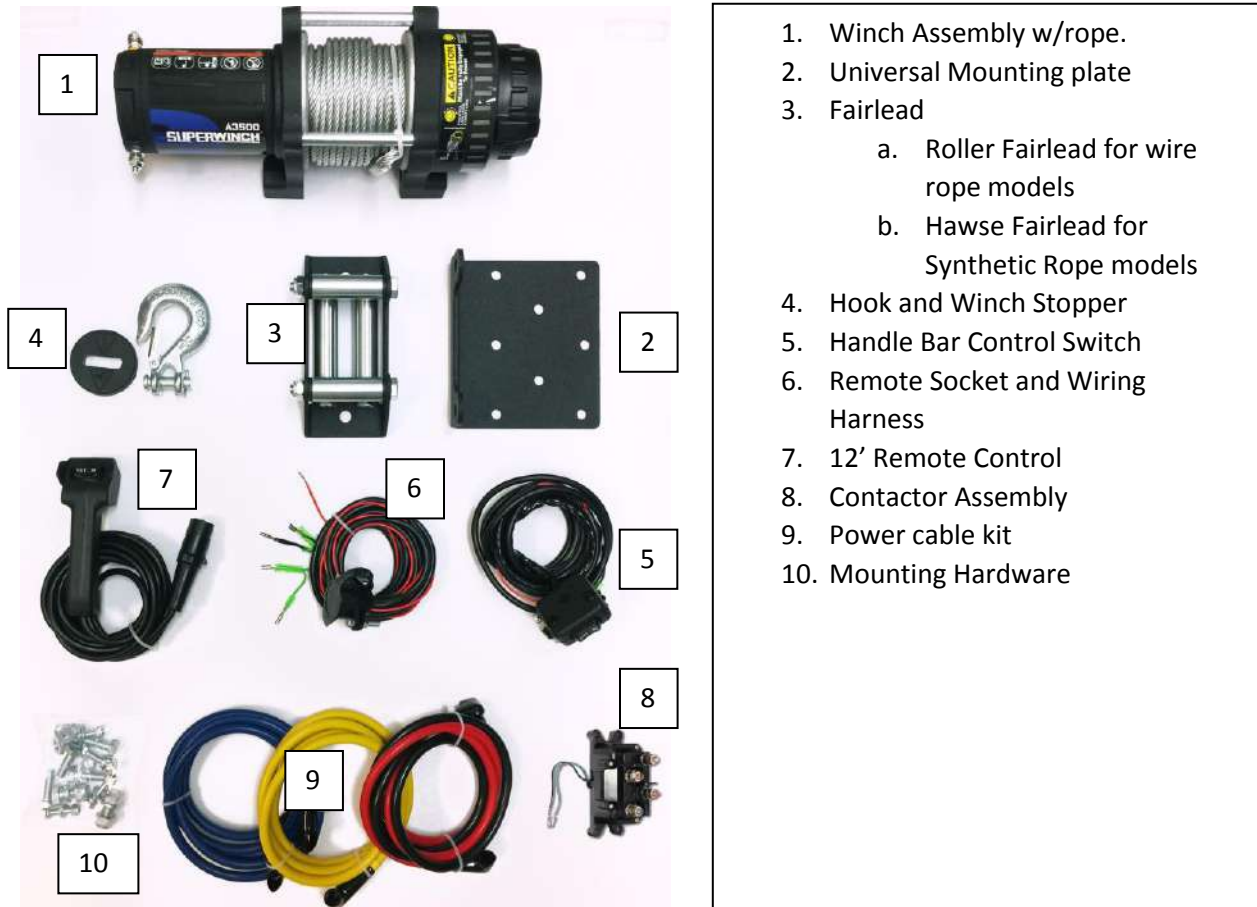

General Description

This winch is equipped with a permanent magnet motor and is designed for intermittent duty general use. The winch is used neither in industrial nor for lifting, never can it be used for moving people. Improper operating could damage your winch and void your warranty.

Free spool clutch is operated by a pull and turn, which can disengage the gearbox, and wire rope will be pulled out by hand with a hand saver bar.

Safety Precautions

1. Never lift people or hoist loads over people. Do not lift items vertically. The winch was designed for ground use only.
2. Never overload. Be sure all equipment used meets the winch's maximum line pull rating. We recommend using the pulley block option to double line the wire rope. (See Fig. 1) Double line with a pulley block to reduce the load on the winch, wire rope and battery. When double-lining, pulley blocks should be rated to a minimum of two times the winch's line pull rating.

WINCH INSTALLATION

STEP 1: MOUNTING THE WINCH

Winch mounting kits and bumpers are available from a variety of manufacturers and retailers to satisfy nearly all applications. Make sure your desired system is rated for the capacity of your winch before purchasing. For information on available kits or recommendations, contact Superwinch customer service.

▲ CAUTION To prevent accidental activation of the winch and serious injury, complete the winch installation and attach the hook before installing the wiring.

▲ WARNING Always choose a mounting location that is sufficiently strong enough to withstand the maximum pulling capacity of your winch.

- Never use bolts that are too long.
- Always spool the winch rope onto the drum in the direction specified by the drum rotation labels on the winch and/or in the documentation. This is required for the automatic brake (if so equipped) to function properly.
- Always wind the winch rope on the bottom (mount side) of the drum.

This winch should always be mounted in a horizontal orientation with the rope winding on/ off the drum on the mount side of the drum and following the drum rotation arrow as labeled on the winch, see Figures 2 and 3.

Correct rotation is required for the automatic brake to function properly. Horizontal mounting helps prevent the rope from piling up on one end of the drum which can damage the winch.

The use of recommended bolt and lock washer combinations torqued to recommended levels will prevent vibration during operation. Specifications listed below. Mounting system will dictate bolt length.

Mounting Bolt Pattern:

Standard: Four bolt, 4.9 in x 3 in

Smooth and flat mounting surface, minimum thickness = 6.4 mm (1/4")

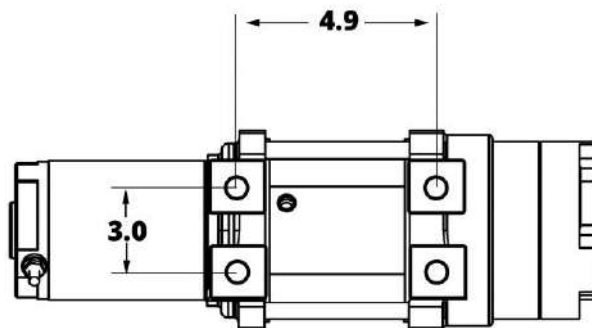

WINCH INSTALLATION Continued

Choose a mounting location that is sufficiently strong enough to withstand the maximum pulling capacity of your winch. Correct installation of your winch is required for proper operation.

1. Mount the winch on the vertical or other fixed installation by using the screw (M8 x 1.25 x 30mm), M8 nut, $\phi 8$ flat washer and $\phi 8$ spring washer (two sets).

WARNING: This winch must be mounted with the wire rope in underwind direction. Improper mounting could damage your winch and void your warranty (See Fig 4.)

- 2.
3. Electric wire-connections for the winch without the control box:
 - a. Route the two couple of lines from the switch to the motor and battery respectively. Connect the red line to the positive (1) terminal and the green (or black) to the negative (2) terminal of the battery. (See Fig. 5)

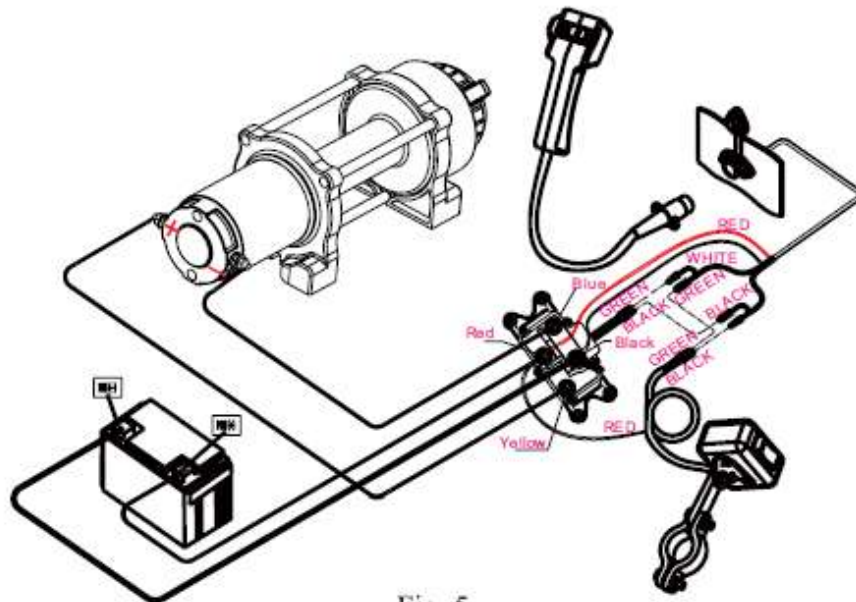
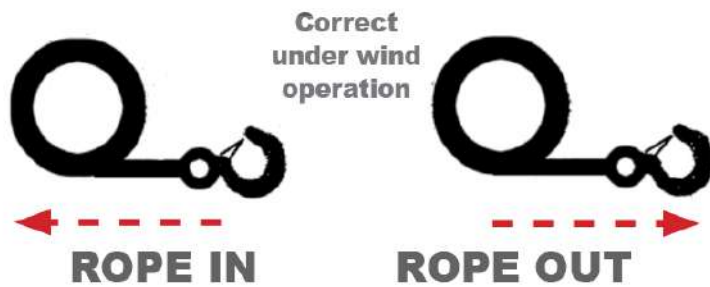

Fig. 5

4. Check the rotating direction of the drum. Pull and turn the clutch knob to the "off" position (drum can be turning free). Pull out some cable from the drum, and then turn the clutch knob to the "in" position. Press the "cable out" button on the handheld switch, if the cable is releasing then it is connected the right way.

Otherwise please change the line connected to the motor. You should exchange the two lines, and repeat the above-mentioned operation.

OPERATION

1. Pull and turn the clutch knob, so the drum can turn free by hand.
2. Always use a hand saver strap.
WARNING: Check that there are at least five turns of wire rope remaining on the drum before operation.
3. Switch clutch knobs back to the “in” position and drum mesh with gear. At the same time the drum can’t be turned by hand.
CAUTION: Clutch must be fully engaged before winching. Never operate the clutch while the drum is turning. Do not readjust the clutch knob as it has been adjusted and permanently locked in place with a thread-locking compound in the factory.
4. Press the “cable in” button on the handheld and the cable will re-spool. Press the “cable out” button to reverse the direction. Wait until the motor stops before reversing directions.
5. Re-spool cable after finishing the operation.

MAINTENANCE

1. Periodically check the tightness of the mounting bolts and electrical connections. Remove all the dirt or corrosion and always keep the winch clean.
2. Do not attempt to disassemble the gearbox. Repairs should be done by the manufacturer or authorized repair center.
3. The gearbox has been lubricated using high temperature lithium grease in the factory. No internal lubrication is required except being repaired.



REPLACE THE ROPE

1. Engage the clutch by turning the clutch knob to the “in” position.
2. When inserting the wire rope into the drum, insert it into the correct end of the hole provided. (See Fig. 12) Tighten the setscrew.
3. Operate the winch and re-spool the wire rope around the drum tightly.

CAUTION: ep stated tensile to ensure the wire rope can be rolled on the drum tightly.

WARNING: Always replaced damaged wire rope with manufacturer’s identical replacement part.

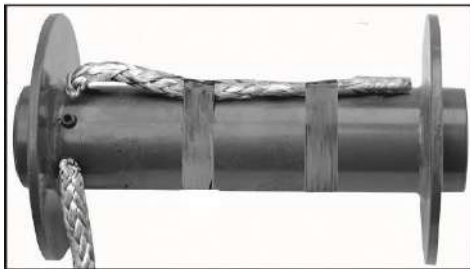

For Synthetic Rope a common method of installing a synthetic rope is through a hole in the drum coming from underneath the drum using enough line so it reaches opposite end of drum. Position the inserted line lengthwise down the drum as shown in Figure 1.

Using duct tape or similar, secure the end of line to drum, taping around drum. A plug or setscrew is not used in this installation.

Be sure that line is wound on from underneath drum, line should come off the drum on bottom

TROUBLESHOOTING

SYMPTOM	POSSIBLE CAUSE	SOLUTION
Motor will not operate or only runs in one direction	-Switch inoperative -Broken wires or bad connection -Defective motor	-Replace switch -Replace wires, connect correctly and screw down the bolts -Replace or repair the motor
Motor runs but drum does not turn	-Clutch not engaged	-Engage clutch
Motor runs but with insufficient power or low line speed	-Weak battery -Defective motor	-Recharge or replace battery -Keep connection terminals clean, tighten or replace connective device -Repair or replace motor
Motor overheating	-Winch running for a long time -Defective motor	

FIRST TIME OPERATING INSTRUCTIONS

Remote Control Switch(s) & Winch Operation

Your new A-Series winch can be operated by either a wired handheld remote or by a handlebar mounted switch.



WIRED REMOTE CONTROL SWITCH

Always understand your winch and the winching operation by reviewing Superwinch Winch User's Guide included with your winch.

The wired remote has a 12' cord with a socket on the end that plugs into the remote socket on the winch. Once plugged in, the operator activates the winch by pressing on;

- A. For "power-In" press button (IN).
- B. For "power-out" press button (OUT)

Do not leave the remote plugged into the winch when not in use. Leaving the remote plugged in may result in a dangerous condition and/or battery drain.

WIRED HANDLEBAR SWITCH



Always understand your winch and the winching operation by reviewing The Basic Guide to Winching Techniques included with your winch.

FIRST TIME OPERATING INSTRUCTIONS (CONTINUED)

Clutch Operation



Never engage or disengage clutch if winch is under load, winch rope is in tension or drum is moving.

The function of the clutch is that when it is engaged, the gear train and winch rope drum are coupled to the winch drum and power can be transferred from the winch motor. When the clutch is disengaged the drum is in the free spool position, uncoupled allowing the drum to rotate freely.

The clutch lever, located on the winch housing opposite the motor, controls the clutch position. To prevent damage, always fully engage or fully disengage the clutch lever.

To manually engage and disengage the clutch, just grab the handle and twist in the direction indicated in the figure right or shown on the label on the winch



Never allow other people to handle or be near the clutch handle when using the auto engagement feature.

When the clutch is in dis-engage you can engage the clutch by tapping the power in button on either the wired or wireless remote to spin the motor. This action drops the clutch into engagement. Once engaged, you then can bring in the slack and begin winching.

Spooling Out



Never operate winch with less than five (5) wraps of rope around the drum.
Rope attachment to the drum is not designed to hold a load.



Always keep hands clear of winch rope, hook loop, hook and fairlead opening during installation, operation, and when spooling in or out.



Always wear heavy leather gloves when handling winch rope.

The quickest and easiest way to spool out winch rope is generally freespooling. Before freespooling winch rope out from the winch, power out enough rope to remove any tension the winch rope might be under. Disengage the clutch. Then freespool by manually spooling out enough winch rope for the winching operation. See Superwinch Winch User's Guide for more information.



Do NOT power out more than 30ft without allowing the winch to cool for 20 minutes before powering rope back in. Instead, place the clutch in freespool and pull the rope out by hand.



Always use supplied hook strap whenever spooling winch rope in or out, during installation or operation to avoid injury to hands and fingers.

FIRST TIME OPERATING INSTRUCTIONS (CONTINUED)

Spooling in Under Load

⚠️ WARNING Never exceed winch's rated line pull.

Power-in the winch rope evenly and tightly on the drum. This prevents the outer winch wraps from sinking into the inner wraps, binding, and damaging the winch rope. Avoid shock loads when spooling, by pulsing the control switch to take up winch rope slack. Shock loads can momentarily far exceed the winch and rope ratings.

Spooling In Under No Load

⚠️ WARNING Never touch winch rope or hook while someone else is at the control switch or during winching operation.

Spooling with an Assistant: Have the assistant hold the hook strap putting as much constant tension on the winch rope as possible. While keeping tension, the assistant should walk toward the winch while you operate the control switch spooling in the winch rope. Release the switch when the hook is a minimum of 6 ft. (2m) from the fairlead opening. Spool in the remainder for storage as directed below.

Spooling Alone: Arrange the winch rope to be spooled so it will not kink or tangle when spooled. Be sure any winch rope on the drum is tightly and evenly layered. Spool enough winch rope to complete the next full layer on the drum. Tighten and straighten the layer. Repeat process until the hook is a minimum of 6 ft. (2 m) from the fairlead opening. Spool in the remainder for storage as directed below.

Spooling Remainder for Storage

When the hook is within 6 ft. (2 m) of the fairlead, disconnect the hook from the anchor or load. Hold onto the supplied hook strap and hold tension on the winch rope. Slowly power-in the winch by "pulsing" the power-in switch on the remote control until the hook is within 3 ft. (1 m) of the fairlead.

Stop winching in and attach the hook to a suitable anchor point on the vehicle.

NOTICE Do not power the hook into the fairlead. This could damage the fairlead.

Once the hook is suitably attached to the vehicle, power-in the remaining slack in the winch rope by "pulsing" the power-in switch on the remote control until there is minimal slack in the winch rope.

Overloading/Overheating

This winch is rated for intermittent duty. When the motor approaches stall speed, very rapid heat buildup occurs which may cause motor damage. Double-line rigging (see The Basic Guide to Winching Techniques) will reduce the amperage draw, and reduce heat buildup in the motor. This allows longer continual use.

FIRST TIME OPERATING INSTRUCTIONS

STRETCHING WINCH ROPE

⚠️ WARNING Always pre-stretch rope and re-spool under load before use. Tightly wound rope reduces chances of "binding", which can damage the rope.

⚠️ WARNING Never operate winch with less than 5 wraps of rope around the drum. The rope attachment to the drum is not designed to hold a load.

The life of a winch rope is directly related to the use and care it receives. During its first use, a new winch rope must be spooled onto its drum under a load of at least 1000 lbs. (454 kgs). Use the following instructions to properly stretch the winch rope onto the winch drum.

- 1) Choose a FLAT AND LEVEL location that is large enough to run out the entire length of winch rope.
- 2) Turn the clutch lever on the winch to the “Free Spool” position. Spool out the winch rope to the last 5 wraps on the drum. Once the winch rope is spooled out, turn the clutch lever on the winch to the “Engaged” position.
- 3) Attach the hook end of the rope to a suitable anchor point and back the vehicle away from the anchor point until there is very little slack in the winch rope. Before getting out of the vehicle, set the parking brake, place the vehicle in gear or park and turn the vehicle off.
- 4) Connect the remote control to the winch. Standing approximately 8 ft. (2.44 m) away from the winch, power-in the winch until all of the slack is wound onto the winch drum. Disconnect the remote control from the winch. Hold tension on the winch rope with one hand; carefully push the winch rope to the side of the drum the winch rope is attached to so there are no gaps between each coil on the drum. Be sure to check that the winch rope is winding off of the bottom of the drum, not the top, or the automatic load holding brake will not function properly. (If the winch rope is winding off the top you have powered the winch “out” instead of “in” on the remote control).
-) The following steps should be done using two people for proper safety. If you attempt to tension your winch rope alone be sure to always engage the parking brake, place the transmission in gear or park and turn the vehicle off every time you exit the vehicle to inspect the winch rope. Never exit the vehicle with a load on the winch rope. Tensioning the winch rope is critical to ensure a long product life. Tensioning the winch rope will prevent outer layers of winch rope from pinching and deforming the inner layers.
- 6) Use care to evenly wrap each layer to prevent damage to the rope.
- 7) Pass the remote control through the driver’s window for the driver of the vehicle to operate. Instruct your assistant to stand to the side of the vehicle and away from the winch rope. Your assistant should signal you if the winch rope is winding correctly by watching it move across the fairlead as the winch rope is powered in. Start the vehicle and place the transmission in neutral. Release the parking brake while applying moderate brake pedal pressure. Press power-in on the remote control switch. After winching in for approximately 6 ft. (2m), stop winching. Slowly let up off of the brake pedal and then apply the parking brake. This will ensure that there is no load on the winch rope. Then place the transmission in park or in gear and turn the vehicle off. Exit the vehicle and inspect the winch to make sure that the winch rope is being evenly wound onto the winch drum and not sinking into the lower layer. If the winch rope is sinking, power the winch rope out and repeat this step from the beginning with more brake pedal pressure.
- 8) When you are convinced the winch rope is winding onto the winch drum properly, repeat step 6 until the vehicle is within 6 ft. (2 m) of the winch anchor. Once within 6 ft. (2 m), slowly let up off of the brake pedal and then apply the parking brake. This will ensure that there is no load on the winch rope. Then place the transmission in park or in gear and turn the vehicle off. Exit the vehicle. Disconnect the hook from the anchor. While holding onto the supplied hook strap, hold tension on the winch rope and slowly power-in the winch by “pulsing” the power-in switch on the remote control until the hook is within 3 ft. (1 m) of the fairlead. Stop winching in and attach the hook to a suitable anchor point on the vehicle.

NOTICE

Do not power the hook into the fairlead. This could cause damage to the fairlead.

Using your winch

RIGGING

Rigging is the act of connecting the pulling mechanism to the anchor point. Rigging often involves materials such as tree saver straps, nylon straps, pulley blocks, and shackles. The use of these materials is discussed later in this section. Regardless of the materials used, selecting the anchor point is vital.

In some circumstances the vehicle on which the winch is mounted is the anchor point. In these situations the vehicle with the winch is not stuck. It is being used to move another object. When anchoring the pulling vehicle, set the parking brake and block or chock the wheels. Keep the vehicle's foot brake depressed and place the automatic or manual transmission in neutral. Always consult vehicle's owner's manual for load capacity and other specifications of your vehicle.

In a vehicle recovery situation where a winch equipped vehicle is NOT being used as the anchor point, always select a solid object that is more than adequate to resist the winch loads applied. This could be a tree, rock or other vehicle. If hooking to a tree or rock always use a tree-saver strap. If using a second vehicle as an anchor point, always be sure that the tow point on the vehicle is securely mounted to the vehicle's frame and will fully resist the winch load.

The anchor point selected should create a straight pull for the winch, as much as possible in the given situation. Long pulls at side angles can damage your winch or rope. In all cases, NEVER wrap the winch rope around a load or anchor point and connect the hook back to the rope. ALWAYS use a strap or tow point to connect the winch hook to the load or anchor point.

For trailering applications, always be sure that the tow point on the vehicle or item to be winched will resist the winch load applied, and will not damage the vehicle, item, or winch rope. Align an unobstructed path to the car that you are loading. Minimize contact with the wire or synthetic rope and the trailer or other objects.

Now that you have selected an anchor point you can begin rigging. No two winching situations are the same. Always wear proper safety equipment suitable to your unique situation.



Figure 7., illustrates one of the most commonly used rigging methods. The winch is mounted to a vehicle, and a nylon strap is used to protect the tree when it is used as an anchor and the rope is attached to the strap. The use of a chain or rope is not recommended due to the damage it could cause to the tree.

Figure 8. illustrates a method of rigging to obtain a mechanical advantage. The use of a pulley block in this way will approximately double overall pulling ability. The winch hook is secured to a secure frame-mounted point on the vehicle (NOT on the winch.) The increase in pulling ability comes from 2 lines now pulling with the same winch tension. (Never

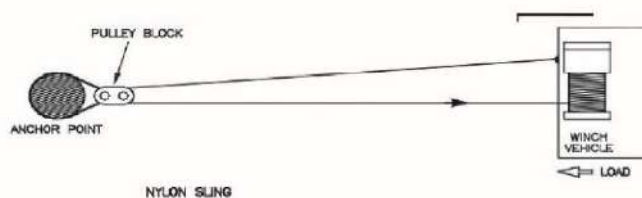

exceed rated winch capacity. Always use a pulley block if more pulling ability is required.)

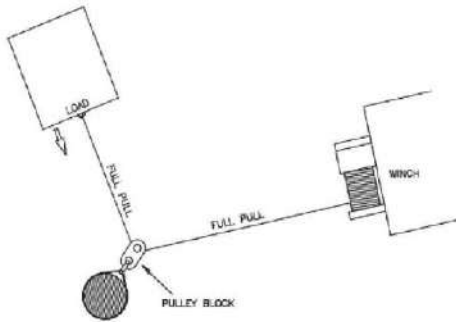
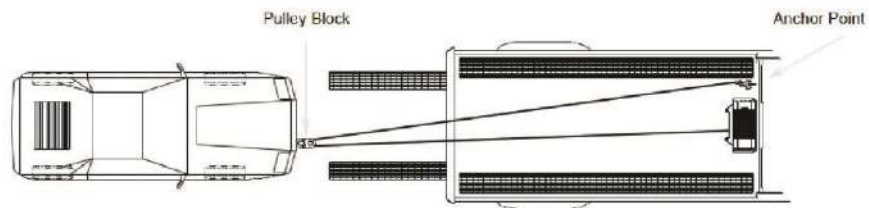

Figure 9. illustrates the use of a pulley block to change the direction of the pull. The pulley block is attached to an anchor point with a nylon strap and shackle, and the winch rope is redirected to the load.

Figure 1

line speed, which can be useful for more delicate operations. The reduction in load is accomplished by there now being 2 lines in tension. Compared to single-line, this will reduce the load on the winch and rope by approximately 1/2.

on the winch, rope and battery. Double-lining also reduces



Be sure all rigging equipment used meets the winch's maximum line pull rating. When double-lining, pulley blocks should be rated to a minimum of two-times (2X) the winch's line pull rating. Always note the winch's rated capacity and do not exceed it.

If you install a tow hook for double-lining, it should be attached/anchored to the vehicle or trailer frame.

Figure11. illustrates proper fairlead use. Equipping the winch with a fairlead will reduce wear on the rope during angle pulls. Rollers reduce rubbing and abrasion to the rope. Always pull as straight as possible to reduce the buildup of rope on one end of the drum. The vehicle's engine should be running during winch operation. If considerable winching is performed with the engine off, the battery may be too weak to restart the engine.



WINCHING

Once the Rigging is set, you are ready to Winch. Always keep safety in mind during winching. Keep all observers a distance from the winching operation equal to the length of rope that is in use.

For recovery applications, understand how the load you're winching will move. If the vehicle is stuck, understand why. Is the vehicle simply in slippery mud? Is an axle or skid plate caught on a rock? Understanding why the vehicle is stuck is a key point. If there is a large rock right in front of your axle, frame, or skid plate, you can winch all day and the only thing you'll accomplish is bending something, or burning out your winch.

Check for obstructions. Sometimes no amount of winching forward will pull the vehicle up and over an obstacle. If the winch is struggling, re-evaluate. Remember—Sometimes the correct path out is back the way you got in.

SECURING AND DE-RIGGING

When the vehicle has been recovered or the load has been moved to a stable position and winching is complete, secure the vehicle or load and release the tension on the rope by powering cable out just enough to slacken the rope. **DO NOT USE THE WINCH TO SECURE LOADS DURING TRANSPORT.** Disassemble the rigging, and return components to their storage area.

Power the winch IN until the hook is approximately 3 feet (1 meter) from the winch. **NEVER** hold the hook with your hand—**ALWAYS** use the handsaver. Secure the hook to its stowed position (a shackle or tow hook) and jog the winch in slowly, approximately 1 second at a time, until the winch cable is snug.

SUMMARY

No basic guide to winching techniques can cover all scenarios that may come up in the real world. The safety of you, the people around you, and your vehicle are, ultimately, your responsibility.

- Inspect your equipment regularly, before and after each use.
- Use only genuine Superwinch® accessories and replacement parts when servicing your winch.
- Do not use damaged equipment.
- Do not use a winch with damaged equipment, or a winch that does not appear to be operating properly.
- Practice rigging and winching, and refresh your knowledge by reading your winch documentation regularly.
- Listen to your winch. Learn to recognize when the winch is pulling easily, and when it is working harder.
- Recognize your winch's speed, which is also an indication of how much load your winch is pulling.
- Avoid long-duration pulls at high loads. Allow the winch to rest, or re-think your rigging.
- Always keep safety a top priority, and be considerate of others and the environment.

Help

For questions about this manual, your winch or winching in general, contact SUPERWINCH before use:

Superwinch
20750 SW 115th Ave
Tualatin, OR 97062 USA
800.323.2031 | info@superwinch.com